

TERMINAL BLOCK 70x45

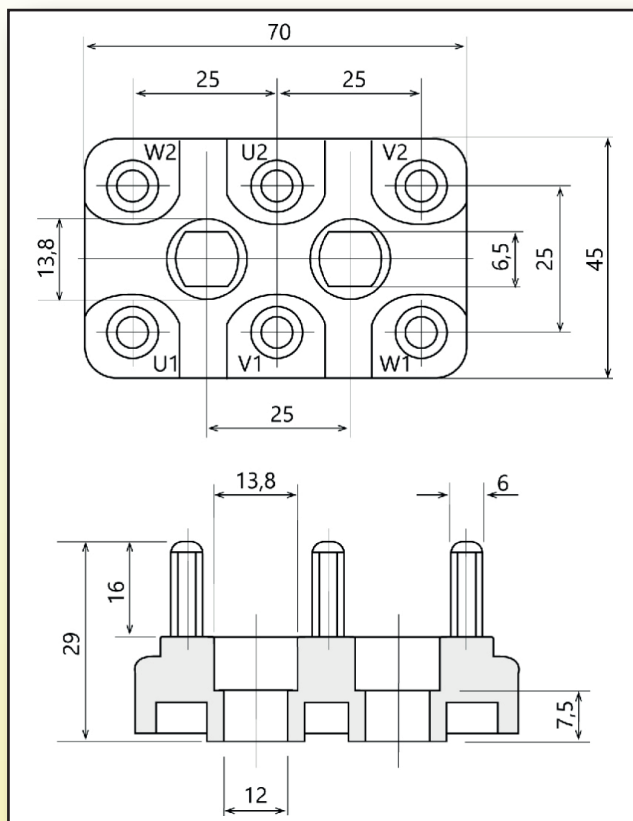

Measures	70x45 mm
Materials	Brass
Pins	6 fixed pins with cylindrical base
Accessories	12 nuts + 12 washers + 3 bridges
Thermal class	F (150°C)
Approval	UL - CSA



RD
&
Components S.r.l.

Via Bergamo 6 - 20835 Muggiò(MB) ITALY
Tel. +39 039 2328773 P.IVA 12934630158
www.rdcomponents.com - www.rdc-service.it

