

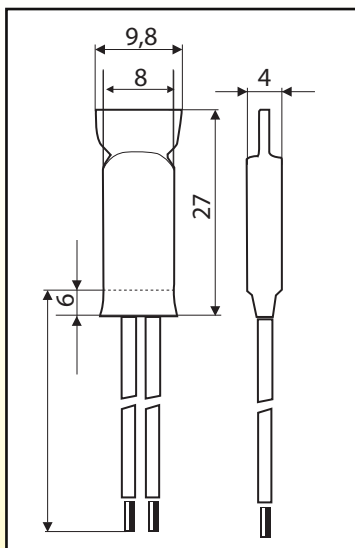

PROTETTORI TERMICI

SERIE AM02



DATI TECNICI

Posizione dei contatti	Normalmente chiusi
Portata dei contatti	2,5A/250V
Numero di cicli	10.000
Portata massima	3,6A/2.000 cicli
Temperatura nominale	65° - 150°C
Tolleranza standard	±5K/±7,5K/±10K
Temperatura di ripristino	30±15K
Isolamento verso massa	2.500V / 50Hz
Omologazioni	VDE, UL



RD
Components S.r.L.

Via Bergamo 6 - 20835 Muggiò(MB) ITALY
Tel. +39 039 2328773 Fax: +39 0392317952
www.rdcomponents.com - www.rdc-service.it

